

## Solutions to AIEEE-2006- PHYSICS

41. A particle located at  $x = 0$  at time  $t = 0$ , starts moving along the positive  $x$ -direction with a velocity 'v' that varies as  $v = \alpha\sqrt{x}$ . The displacement of the particle varies with time as
- (1)  $t^3$  (2)  $t^2$   
(3)  $t$  (4)  $t^{1/2}$

**Ans:** (2)

**Sol.**  $\frac{dx}{dt} = \alpha \int \frac{dx}{\sqrt{x}} = \int \alpha dt \Rightarrow x \propto t^2$

42. A mass of  $M$  kg is suspended by a weightless string. The horizontal force that is required to displace it until the string makes an angle of  $45^\circ$  with the initial vertical direction is

- (1)  $Mg(\sqrt{2} - 1)$  (2)  $Mg(\sqrt{2} + 1)$   
(3)  $Mg\sqrt{2}$  (4)  $\frac{Mg}{\sqrt{2}}$

**Ans:** (1)

**Sol.**  $F \ell \sin 45 = Mg (\ell - \ell \cos 45)$   
 $F = Mg (\sqrt{2} - 1)$

43. A bomb of mass 16 kg at rest explodes into two pieces of masses of 4 kg and 12 kg. The velocity of the 12 kg mass is  $4 \text{ ms}^{-1}$ . The kinetic energy of the other mass is

- (1) 96 J (2) 144 J  
(3) 288 J (4) 192 J

**Ans:** (3)

**Sol.**  $m_1 v_1 = m_2 v_2$   
 $KE = \frac{1}{2} m_2 v_2^2 = \frac{1}{2} \times 4 \times 144 = 288 \text{ J}$

44. A particle of mass 100 g is thrown vertically upwards with a speed of 5 m/s. the work done by the force of gravity during the time the particle goes up is

- (1) 0.5 J (2) -0.5 J  
(3) -1.25 J (4) 1.25 J

**Ans:** (3)

**Sol.**  $-mgh = -mg \left( \frac{v^2}{2g} \right) = -1.25 \text{ J}$ .

45. A whistle producing sound waves of frequencies 9500 Hz and above is approaching a stationary person with speed  $v \text{ ms}^{-1}$ . The velocity of sound in air is  $300 \text{ ms}^{-1}$ . If the person can hear frequencies upto a maximum of 10,000 Hz, the maximum value of  $v$  upto which he can hear the whistle is

- (1)  $30 \text{ ms}^{-1}$  (2)  $15\sqrt{2} \text{ ms}^{-1}$   
(3)  $15/\sqrt{2} \text{ ms}^{-1}$  (4)  $15 \text{ ms}^{-1}$

**Ans:** (4)

**Sol.**  $f_{\text{app}} = \frac{f(300)}{300 - v} \Rightarrow v = 15 \text{ m/s}$

46. A electric dipole is placed at an angle of  $30^\circ$  to a non-uniform electric field. The dipole will experience

## Solutions to AIEEE–2006- PHYSICS

---

- (1) a torque only
- (2) a translational force only in the direction of the field
- (3) a translational force only in a direction normal to the direction of the field
- (4) a torque as well as a translational force

**Ans:** (4)

**Sol.** A torque as well as a translational force

47. A material 'B' has twice the specific resistance of 'A'. A circular wire made of 'B' has twice the diameter of a wire made of 'A'. Then for the two wires to have the same resistance, the ratio  $\ell_A / \ell_B$  of their respective lengths must be

- (1) 2
- (2) 1
- (3)  $\frac{1}{2}$
- (4)  $\frac{1}{4}$

**Ans:** (1)

**Sol.**  $R_1 = \frac{\rho_A \ell_A}{\pi R_A^2}$        $R_2 = \frac{\rho_B \ell_B}{\pi R_B^2}$

$$\frac{\ell_A}{\ell_B} = \frac{\rho_B R_A^2}{\rho_A R_B^2} = \frac{2\rho_A R_A^2}{\rho_A \cdot 4R_A^2} \Rightarrow \frac{\ell_B}{\ell_A} = 2$$

48. The Kirchhoff's first law ( $\sum i = 0$ ) and second law ( $\sum iR = \sum E$ ), where the symbols have their usual meanings, are respectively based on

- (1) conservation of charge, conservation of energy
- (2) conservation of charge, conservation of momentum
- (3) conservation of energy, conservation of charge
- (4) conservation of momentum, conservation of charge

**Ans:** (1)

**Sol.** Conservation of charge, conservation of energy

49. In a region, steady and uniform electric and magnetic fields are present. These two fields are parallel to each other. A charged particle is released from rest in this region. The path of the particle will be a

- (1) circle
- (2) helix
- (3) straight line
- (4) ellipse

**Ans:** (3)

**Sol.** Straight line

50. Needles  $N_1$ ,  $N_2$  and  $N_3$  are made of a ferromagnetic, a paramagnetic and a diamagnetic substance respectively. A magnet when brought close to them will

- (1) attract all three of them
- (2) attract  $N_1$  and  $N_2$  strongly but repel  $N_3$
- (3) attract  $N_1$  strongly,  $N_2$  weakly and repel  $N_3$  weakly
- (4) attract  $N_1$  strongly, but repel  $N_2$  and  $N_3$  weakly

**Ans:** (3)

**Sol.** attracts  $N_1$  strongly,  $N_2$  weakly and Repel  $N_3$  weakly

51. Which of the following units denotes the dimensions  $ML^2/Q^2$ , where Q denotes the electric charge?
-

## Solutions to AIEEE–2006- PHYSICS

- (1) Weber (Wb)  
(3) Henry (H)

- (2)  $\text{Wb/m}^2$   
(4)  $\text{H/m}^2$

**Ans:** (3)

**Sol.** Henry (H)

52. A player caught a cricket ball of mass 150 g moving at a rate of 20 m/s. If the catching process is completed in 0.1 s, the force of the blow exerted by the ball on the hand of the player is equal to  
(1) 300 N  
(3) 3 N  
(2) 150 N  
(4) 30 N

**Ans:** (4)

**Sol.**  $(mv - 0) \Rightarrow 0.15 \times 20$   
 $F = \frac{3}{0.1} = 30\text{N}$

53. A ball of mass 0.2 kg is thrown vertically upwards by applying a force by hand. If the hand moves 0.2 m which applying the force and the ball goes upto 2 m height further, find the magnitude of the force. Consider  $g = 10 \text{ m/s}^2$   
(1) 22 N  
(3) 16 N  
(2) 4 N  
(4) 20 N

**Ans:** (4)

**Sol.**  $mgh = Fs$   
 $F = 20 \text{ N}$

54. Consider a two particle system with particles having masses  $m_1$  and  $m_2$ . If the first particle is pushed towards the centre of mass through a distance  $d$ , by what distance should the second particle be moved, so as to keep the centre of mass at the same position?

- (1)  $d$   
(3)  $\frac{m_1}{m_1 + m_2} d$   
(2)  $\frac{m_2}{m_1} d$   
(4)  $\frac{m_1}{m_2} d$

**Ans:** (4)

**Sol.**  $m_1 d + m_2 x = 0$   
 $x = \frac{m_1 d}{m_2}$

55. Starting from the origin, a body oscillates simple harmonically with a period of 2 s. After what time will its kinetic energy be 75% of the total energy?

- (1)  $\frac{1}{12} \text{ s}$   
(3)  $\frac{1}{4} \text{ s}$   
(2)  $\frac{1}{6} \text{ s}$   
(4)  $\frac{1}{3} \text{ s}$

**Ans:** (2)

**Sol.**  $\frac{1}{2} mv^2 = \frac{3}{4} \left( \frac{1}{2} mv_{\text{max}}^2 \right)$   
 $A^2 \omega^2 \cos^2 \omega t \Rightarrow \frac{3}{4} A^2 \omega^2$

## Solutions to AIEEE–2006- PHYSICS

---

$$\cos \omega t = \frac{\sqrt{3}}{2}$$

$$\omega t = \frac{\pi}{6} \Rightarrow t = \frac{1}{6} \text{ sec}$$

56. The maximum velocity of a particle, executing simple harmonic motion with an amplitude 7 mm, is 4.4 m/s. The period of oscillation is

- (1) 100 s (2) 0.01 s  
(3) 10 s (4) 0.1 s

**Ans:** (2)

**Sol.**  $A\omega = v_{\max}$   
 $T = \frac{2\pi}{\omega} = \frac{2\pi A}{v_{\max}} = 0.01 \text{ sec}$

57. A string is stretched between fixed points separated by 75 cm. It is observed to have resonant frequencies of 420 Hz and 315 Hz. There are no other resonant frequencies between these two. Then, the lowest resonant frequency for this string is

- (1) 10.5 Hz (2) 105 Hz  
(3) 1.05 Hz (4) 1050 Hz

**Ans:** (2)

**Sol.**  $\frac{n}{2\ell} v = 315, \frac{(n+1)}{2\ell} v = 420$

Solving  $\frac{v}{2\ell} = 105$

58. Assuming the sun to be a spherical body of radius R at a temperature of T K, evaluate the total radiant power, incident on Earth, at a distance r from the Sun.

- (1)  $\frac{R^2 \sigma T^4}{r^2}$  (2)  $\frac{4\pi r_0^2 R^2 \sigma T^4}{r^2}$   
(3)  $\frac{\pi r_0^2 R^2 \sigma T^4}{r^2}$  (4)  $\frac{r_0^2 R^2 \sigma T^4}{4\pi r^2}$

where  $r_0$  is the radius of the Earth and  $\sigma$  is Stefan's constant.

**Ans:** (3)

**Sol.**  $\frac{\pi r_0^2}{4\pi r^2} (\sigma T^4 \cdot 4\pi R^2) = \frac{\sigma \pi T^4 R^2 r_0^2}{r^2}$

59. The refractive index of glass is 1.520 for red light and 1.525 for blue light. Let  $D_1$  and  $D_2$  be an of minimum deviation for red and blue light respectively in a prism of this glass. Then

- (1)  $D_1 > D_2$   
(2)  $D_1 < D_2$   
(3)  $D_1 = D_2$   
(4)  $D_1$  can be less than or greater than depending upon the angle of prism

**Ans:** (2)

**Sol.**  $D = (\mu - 1)A$   
 $D_2 > D_1$

---

## Solutions to AIEEE–2006- PHYSICS

60. In a Wheatstone's bridge, three resistances P, Q and R are connected in the three arms and the fourth arm is formed by two resistances  $S_1$  and  $S_2$  connected in parallel. The condition for the bridge to be balanced will be

$$(1) \frac{P}{Q} = \frac{R}{S_1 + S_2}$$

$$(2) \frac{P}{Q} = \frac{2R}{S_1 + S_2}$$

$$(3) \frac{P}{Q} = \frac{R(S_1 + S_2)}{S_1 S_2}$$

$$(4) \frac{P}{Q} = \frac{R(S_1 + S_2)}{2S_1 S_2}$$

**Ans:** (3)

**Sol.** 
$$\frac{P}{Q} = \frac{R(S_1 + S_2)}{S_1 S_2}$$

61. The current  $I$  drawn from the 5 volt source will be  
 (1) 0.17 A (2) 0.33 A  
 (3) 0.5 A (4) 0.67 A

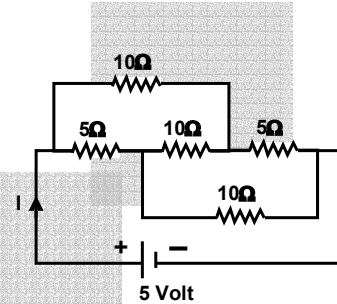

**Ans:** (3)

**Sol.** 
$$i = \frac{5}{10} = 0.5$$

62. In a series resonant LCR circuit, the voltage across R is 100 volts and  $R = 1 \text{ k}\Omega$  with  $C = 2 \mu\text{F}$ . The resonant frequency  $\omega$  is 200 rad/s. At resonance the voltage across L is  
 (1)  $4 \times 10^{-3} \text{ V}$  (2)  $2.5 \times 10^{-2} \text{ V}$   
 (3) 40 V (4) 250 V

**Ans:** (4)

**Sol.** 
$$i = \frac{100}{1000} = 0.1 \text{ A}$$

$$V_L = V_C = \frac{0.1}{200 \times 2 \times 10^{-6}} = 250 \text{ V}$$

63. Two insulating plates are both uniformly charged in such a way that the potential difference between them is  $V_2 - V_1 = 20 \text{ V}$ . (i.e. plate 2 is at a higher potential). The plates are separated by  $d = 0.1 \text{ m}$  and can be treated as infinitely large. An electron is released from rest on the inner surface of plate 1. What is its speed when it hits plate 2?  
 ( $e = 1.6 \times 10^{-19} \text{ C}$ ,  $m_e = 9.11 \times 10^{-31} \text{ kg}$ )

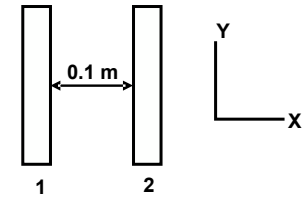

$$(1) 32 \times 10^{-19} \text{ m/s}$$

$$(2) 2.65 \times 10^6 \text{ m/s}$$

$$(3) 7.02 \times 10^{12} \text{ m/s}$$

$$(4) 1.87 \times 10^6 \text{ m/s}$$

**Ans:** (2)

**Sol.** 
$$\frac{1}{2}mv^2 = eV$$

$$v = \sqrt{\frac{2eV}{m}} = 2.65 \times 10^6 \text{ m/s}$$

64. The resistance of a bulb filament is  $100 \Omega$  at a temperature of  $100^\circ\text{C}$ . If its temperature coefficient of resistance be 0.005 per  $^\circ\text{C}$ , its resistance will become  $200 \Omega$  at a temperature of  
 (1)  $200^\circ\text{C}$  (2)  $300^\circ\text{C}$   
 (3)  $400^\circ\text{C}$  (4)  $500^\circ\text{C}$

**Ans:** (2)

## Solutions to AIEEE–2006- PHYSICS

---

**Sol.**  $200 = 100[1 + (0.005 \times \Delta t)]$

$T - 100 = 200$

$T = 300^\circ \text{C}$

65. In an AC generator, a coil with  $N$  turns, all of the same area  $A$  and total resistance  $R$ , rotates with frequency  $\omega$  in a magnetic field  $B$ . The maximum value of emf generated in the coil is ‘

(1)  $N.A.B.\omega$

(2)  $N.A.B.R.\omega$

(3)  $N.A.B$

(4)  $N.A.B.R$

**Ans:** (1)

**Sol.**  $NBA\omega$

66. The flux linked with a coil at any instant ‘ $t$ ’ is given by

$$\phi = 10t^2 - 50t + 250$$

The induced emf at  $t = 3$  s is

(1) 190 V

(2) -190 V

(3) -10 V

(4) 10 V

**Ans:** (3)

**Sol.**  $e = -\frac{d\phi}{dt} = -(20t - 50) = -10$  volt

67. A thermocouple is made from two metals, Antimony and Bismuth. If one junction of the couple is kept hot and the other is kept cold then, an electric current will

(1) flow from Antimony to Bismuth at the cold junction

(2) flow from Antimony to Bismuth at the hot junction

(3) flow from Bismuth to Antimony at the cold junction

(4) not flow through the thermocouple

**Ans:** (1)

**Sol.** Flow from Antimony to Bismuth at cold junction

68. The time by a photoelectron to come out after the photon strikes is approximately

(1)  $10^{-1}$  s

(2)  $10^{-4}$  s

(3)  $10^{-10}$  s

(4)  $10^{-16}$  s

**Ans:** (3)

**Sol.**  $10^{-10}$  sec.

69. An alpha nucleus of energy  $\frac{1}{2}mv^2$  bombards a heavy nuclear target of charge  $Ze$ . Then the distance of closest approach for the alpha nucleus will be proportional to

(1)  $\frac{1}{Ze}$

(2)  $v^2$

(3)  $\frac{1}{m}$

(4)  $\frac{1}{v^4}$

**Ans:** (3)

---

## Solutions to AIEEE–2006- PHYSICS

**Sol.**  $\frac{1}{m}$

70. The threshold frequency for a metallic surface corresponds to an energy of 6.2 eV, and the stopping potential for a radiation incident on this surface 5 V. The incident radiation lies in  
 (1) X-ray region (2) ultra-violet region  
 (3) infra-red region (4) visible region

**Ans:** (2)

**Sol.**  $\lambda = \frac{1242 \text{ eVnm}}{11.2} \approx 1100 \text{ \AA}$

Ultraviolet region

71. The energy spectrum of  $\beta$ -particles [number  $N(E)$  as a function of  $\beta$ -energy  $E$ ] emitted from a radioactive source is  
 (1) (2)

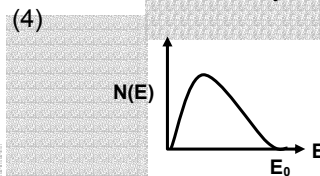
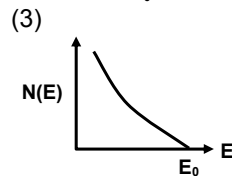
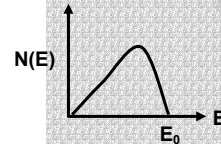
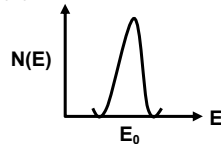

**Ans:** (4)

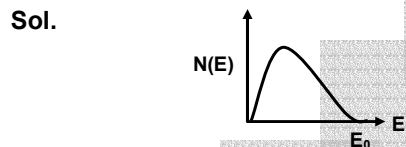

72. When  ${}_3\text{Li}^7$  nuclei are bombarded by protons, and the resultant nuclei are  ${}_4\text{Be}^8$ , the emitted particles will be  
 (1) neutrons (2) alpha particles  
 (3) beta particles (4) gamma photons

**Ans:** (4)

**Sol.** Gamma-photon

73. A solid which is transparent to visible light and whose conductivity increases with temperature is formed by  
 (1) Metallic binding (2) Ionic binding  
 (3) Covalent binding (4) Van der Waals binding

**Ans:** (3)

**Sol.** Covalent binding

## Solutions to AIEEE–2006- PHYSICS

74. If the ratio of the concentration of electrons that of holes in a semiconductor is  $\frac{7}{5}$  and the ratio of currents is  $\frac{7}{4}$ , then what is the ratio of their drift velocities?

(1)  $\frac{4}{7}$

(2)  $\frac{5}{8}$

(3)  $\frac{4}{5}$

(4)  $\frac{5}{4}$

**Ans: (4)**

**Sol.**  $\frac{n_e}{n_n} = \frac{7}{5}$   $\frac{i_e}{i_n} = \frac{7}{4}$

$$\frac{(V_d)_e}{(V_d)_n} \Rightarrow \frac{i_e}{i_n} \times \frac{n_n}{n_e} = \frac{5}{4}$$

75. In a common base mode of a transistor, the collector current is 5.488 mA for an emit current of 5.60 mA. The value of the base current amplification factor ( $\beta$ ) will be

(1) 48

(2) 49

(3) 50

(4) 51

**Ans: (2)**

**Sol.**  $i_b = i_e - i_c$

$$\beta = \frac{i_c}{i_b} = 49$$

76. The potential energy of a 1 kg particle free move along the x-axis is given by

$$V(x) = \left( \frac{x^4}{4} - \frac{x^2}{2} \right) \text{ J}$$

The total mechanical energy of the particle 2 J. Then, the maximum speed (in m/s) is

(1) 2

(2)  $3/\sqrt{2}$

(3)  $\sqrt{2}$

(4)  $1/\sqrt{2}$

**Ans: (2)**

**Sol.**  $K E_{\max} = E_T - U_{\min}$   
 $U_{\min} (\pm 1) = -1/4 \text{ J}$

$$KE_{\max} = 9/4 \text{ J} \Rightarrow U = \frac{3}{\sqrt{2}} \text{ J}$$

77. A force of  $-F\hat{k}$  acts on O, the origin of the coordinate system. The torque about the point (1, -1) is

(1)  $-F(\hat{i} - \hat{j})$

(2)  $F(\hat{i} - \hat{j})$

(3)  $-F(\hat{i} + \hat{j})$

(4)  $F(\hat{i} + \hat{j})$

**Ans: (3)**

**Sol.**  $\vec{\tau} = (-\hat{i} + \hat{j}) \times (-F\hat{k})$   
 $= -F(\hat{i} + \hat{j})$



## Solutions to AIEEE-2006- PHYSICS

---

78. A thin circular ring of mass  $m$  and radius  $R$  is rotating about its axis with a constant angular velocity  $\omega$ . Two objects each of mass  $M$  are attached gently to the opposite ends of a diameter of the ring. The ring now rotates with an angular velocity  $\omega'$  =

(1)  $\frac{\omega m}{(m + 2M)}$  (2)  $\frac{\omega(m + 2M)}{m}$   
(3)  $\frac{\omega(m - 2M)}{(m + 2M)}$  (4)  $\frac{\omega m}{(m + M)}$

**Ans:** (1)

**Sol.**  $L_i = L_f$   
 $mR^2\omega = (mR^2 + 2MR^2)\omega'$   
 $\omega' = \left( \frac{m\omega}{m + 2M} \right)$

79. If the terminal speed of a sphere of gold (density =  $19.5 \text{ kg/m}^3$ ) is  $0.2 \text{ m/s}$  in a viscous liquid (density =  $1.5 \text{ kg/m}^3$ ) of the same size in the same liquid.

(1)  $0.2 \text{ m/s}$  (2)  $0.4 \text{ m/s}$   
(3)  $0.133 \text{ m/s}$  (4)  $0.1 \text{ m/s}$

**Ans:** (4)

**Sol.**  $\frac{v_s}{v_g} = \frac{(\rho_s - \rho_l)}{(\rho_g - \rho_l)}$   
 $v_s = 0.1 \text{ m/s}$

80. The work of  $146 \text{ kJ}$  is performed in order to compress one kilo mole of gas adiabatically and in this process the temperature of the gas increases by  $7^\circ \text{C}$ . The gas is

( $R = 8.3 \text{ J mol}^{-1} \text{ K}^{-1}$ )  
(1) monoatomic (2) diatomic  
(3) triatomic (4) a mixture of monoatomic and diatomic

**Ans:** (2)

**Sol.**  $146 = C_v \Delta T$   
 $\Rightarrow C_v = 21 \text{ J/mol K}$

81. The rms value of the electric field of the light coming from the Sun is  $720 \text{ N/C}$ . The average total energy density of the electromagnetic wave is

(1)  $3.3 \times 10^{-3} \text{ J/m}^3$  (2)  $4.58 \times 10^{-6} \text{ J/m}^3$   
(3)  $6.37 \times 10^{-9} \text{ J/m}^3$  (4)  $81.35 \times 10^{-12} \text{ J/m}^3$

**Ans:** (2)

**Sol.**  $U_{av} = \epsilon_0 E_{rms}^2 = 4.58 \times 10^{-6} \text{ J/m}^3$   
 $E_{rms}^2 = 4.58 \times 10^{-6} \text{ J/m}^3$

82. A coin is placed on a horizontal platform which undergoes vertical simple harmonic motion of angular frequency  $\omega$ . The amplitude of oscillation is gradually increased. The coin will leave contact with the platform for the first time

(1) at the highest position of the platform (2) at the mean position of the platform  
(3) for an amplitude of  $\frac{g}{\omega^2}$  (4) for an amplitude of  $\frac{g^2}{\omega^2}$

**Ans:** (3)

**Sol.**  $A\omega^2 = g$   
 $\Rightarrow A = g/\omega^2$

---

## Solutions to AIEEE–2006- PHYSICS

83. An electric bulb is rated 220 volt – 100 watt. The power consumed by it when operated on 110 volt will be  
 (1) 50 watt (2) 75 watt  
 (3) 40 watt (4) 25 watt

**Ans: (4)**

**Sol.**  $\frac{V_1^2}{P_1} = \frac{V_2^2}{P_2} = \text{Resistance}$   
 $\Rightarrow P_2 = 25 \text{ W}$

84. The anode voltage of a photocell is kept fixed. The wavelength  $\lambda$  of the light falling on the cathode is gradually changed. The plate current  $I$  of the photocell varies as follows :

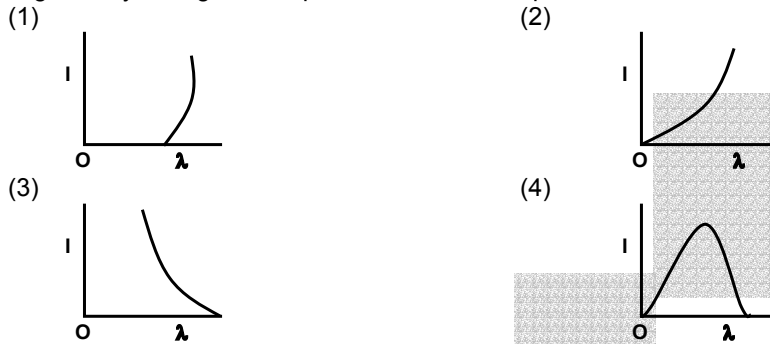

**Ans: (3)**

85. The 'rad' is the correct unit used to report the measurement of  
 (1) the rate of decay of radioactive source  
 (2) the ability of a beam of gamma ray photons to produce ions in a target  
 (3) the energy delivered by radiation to a target.  
 (4) the biological effect of radiation

**Ans: (4)**

86. If the binding energy per nucleon in  ${}^7_3\text{Li}$  and  ${}^4_2\text{He}$  nuclei are 5.60 MeV and 7.06 MeV respectively, then in the reaction

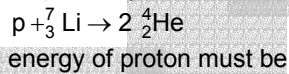

- (1) 39.2 MeV (2) 28.24 MeV  
 (3) 17.28 MeV (4) 1.46 MeV

**Ans: (3)**

**Sol.**  $E_p = (8 \times 7.06 - 7 \times 5.60) \text{ MeV} = 17.28 \text{ MeV}$

87. If the lattice constant of this semiconductor is decreased, then which of the following is correct?

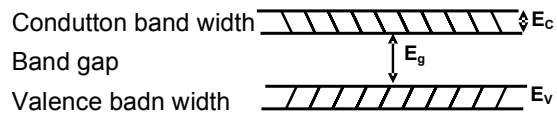

- (1) All  $E_c$ ,  $E_g$ ,  $E_v$  decrease  
 (2) All  $E_c$ ,  $E_g$ ,  $E_v$  increase  
 (3)  $E_c$ , and  $E_v$  increase but  $E_g$  decreases  
 (4)  $E_c$ , and  $E_v$ , decrease  $E_g$  increases

**Ans: (4)**

## Solutions to AIEEE-2006- PHYSICS

88. In the following, which one of the diodes is reverse biased?  
 (1) (2)

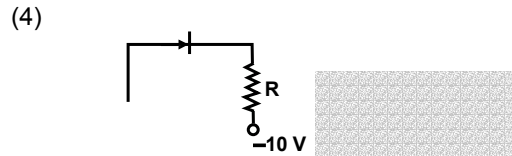
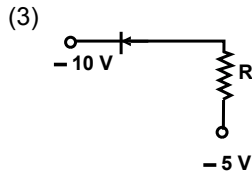
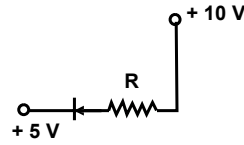
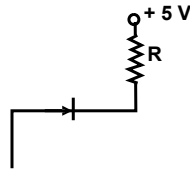

**Ans:** (1)

89. The circuit has two oppositely connect ideal diodes in parallel. What is the current following in the circuit?

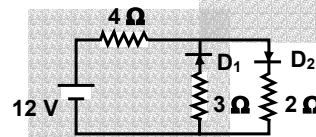

- (1) 1.33 A (2) 1.71 A  
 (3) 2.00 A (4) 2.31 A

**Ans:** (3)

**Sol.**  $D_1$  is reverse biased therefore it will act like an open circuit.

$$i = \frac{12}{6} = 2.00 \text{ A}$$

90. A long solenoid has 200 turns per cm and carries a current  $i$ . The magnetic field at its centre is  $6.28 \times 10^{-2}$  Weber/m<sup>2</sup>. Another long solenoid has 100 turns per cm and it carries a current  $i/3$ . The value of the magnetic field at its centre is

- (1)  $1.05 \times 10^{-4}$  Weber/m<sup>2</sup> (2)  $1.05 \times 10^{-2}$  Weber/m<sup>2</sup>  
 (3)  $1.05 \times 10^{-5}$  Weber/m<sup>2</sup> (4)  $1.05 \times 10^{-3}$  Weber/m<sup>2</sup>

**Ans:** (2)

**Sol.** 
$$B_2 = \frac{B_1 n_1 i_1}{n_2 i_2} = \frac{(6.28 \times 10^{-2})(100 \times i/3)}{200(i)} = 1.05 \times 10^{-2} \text{ W/m}^2$$

91. Four point masses, each of value  $m$ , are placed at the corners of a square ABCD of side  $\ell$ . The moment of inertia through A and parallel to BD is

- (1)  $m\ell^2$  (2)  $2m\ell^2$   
 (3)  $\sqrt{3}m\ell^2$  (4)  $3m\ell^2$

**Ans:** (4)

**Sol.** 
$$I = 2m (\ell/\sqrt{2})^2 = 3m\ell^2$$

92. A wire elongates by  $\ell$  mm when a load  $W$  is hanged from it. If the wire goes over a pulley and two weights  $W$  each are hung at the two ends, the elongation of the wire will be (in mm)

- (1)  $\ell/2$  (2)  $\ell$   
 (3)  $2\ell$  (4) zero

## Solutions to AIEEE–2006- PHYSICS

**Ans: (2)**

93. Two rigid boxes containing different ideal gases are placed on a table. Box A contains one mole of nitrogen at temperature  $T_0$ , while Box B contains one mole of helium at temperature  $(7/3) T_0$ . The boxes are then put into thermal contact with each other and heat flows between them until the gases reach a common final temperature. (Ignore the heat capacity of boxes). Then, the final temperature of the gases,  $T_f$ , in terms of  $T_0$  is

(1)  $T_f = \frac{5}{2} T_0$

(2)  $T_f = \frac{3}{7} T_0$

(3)  $T_f = \frac{7}{3} T_0$

(4)  $T_f = \frac{3}{2} T_0$

**Ans: (4)**

**Sol.**  $\Delta U = 0$

$$\Rightarrow \frac{3}{2}R(T_f - T_0) + 1 \times \frac{5}{2}R(T_f - \frac{7}{3}T_0) = 0$$

$$T_f = \frac{3}{2}T_0$$

94. Two spherical conductors A and B of radii 1 mm and 2 mm are separated by a distance of 5 cm and are uniformly charged. If the spheres are connected by a conducting wire then in equilibrium condition, the ratio of the magnitude of the electric fields at the surface of spheres A and B is

(1) 1 : 4

(2) 4 : 1

(3) 1 : 2

(4) 2 : 1

**Ans: (4)**

**Sol.**  $\frac{E_A}{E_B} = \frac{r_B}{r_A} = \frac{2}{1}$

95. An inductor ( $L = 100$  mH), a resistor ( $R = 100 \Omega$ ) and a battery ( $E = 100$  V) are initially connected in series as shown in the figure. After a long time the battery is disconnected after short circuiting the points A and B. The current in the circuit 1 ms after the circuit is

(1) 1 A

(2)  $1/e$  A

(3)  $e$  A

(4) 0.1 A

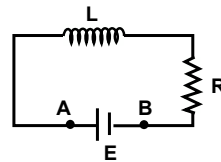

**Ans: (2)**

**Sol.**  $I = I_0 e^{-Rt/L} = \frac{1}{e}$  A

\*\*\*\*\*